



**Gun Repair Kit
No. 702736**

Technical Bulletin

Professional Gravity Feed Basecoat Spray Gun



DEVILBISS
AUTOMOTIVE REFINISHING

askus@carlisleleft.com
800.445.3988
www.autorefinishdevilbiss.com



Table of Contents

Topic	Page
EC Declaration of Conformity	3
Operational Description	3
Construction Features, Materials of Construction, Specifications & Technical Data	4
Safety Precautions	5
Installation, Operation, Preventive Maintenance & Cleaning, Spray Gun Lubrication	6
Parts Replacement/Maintenance	7-12
A. Servicing Air Valve	7
B. Replacing Air Valve	8
C. Needle Packing, Fluid Insert, Spreader Valve Assembly	9
D. Air Separator Seal	10
E. Chart 1 – Air Caps	11
Chart 2 – Fluid Nozzles & Fluid Needles	
F. Exploded View and Parts List	12
Troubleshooting Possible Problems in Operation	13-14
Accessories	14
Warranty	15

NOTE:

When used with the HVLP cap, this gun can be used anywhere—both in mandated HVLP and unregulated areas.

Consult your local air quality management agency with any questions regarding HVLP or compliance requirements in your area.



Technical Bulletin

TEKNA Basecoat Gravity Feed Spray Gun

IMPORTANT: Read and follow all instructions and Safety Precautions before using this equipment. Keep for future use.

EC Declaration of Conformity

We, Finishing Brands UK, Ltd., Ringwood Rd, Bournemouth, Dorset, BH11 9LH, UK, as the manufacturer of the spray gun model **TEKNA BASECOAT**, declare, under our sole responsibility, that the equipment to which this document relates is in conformity with the following standards or other normative documents:

BS EN 12100 PARTS 1 & 2: 2010, BS EN 1953: 1998+A1:2009; and thereby conform to the protection requirements of Council Directive 98/37/EEC relating to Machinery Safety Directive, and;

EN 13463-1:2009, council Directive 94/9/EC relating to Equipment and Protective Systems intended for use in Potentially Explosive Atmospheres protection level II 2 G X.

This product also complies with the requirements of the EPA guidelines, PG6/34. Transfer efficiency certificates are available on request.

D Smith, General Manager
October 2015

The TEKNA BASECOAT Gravity Feed Spray Gun Kit complies to ATEX regulations 94/9/EC, protection level **II 2 G X**, **Suitable for use in Zones 1 and 2.**

DeVilbiss Automotive Refinishing reserves the right to modify equipment specification without prior notice.

Operational Description

The TEKNA BASECOAT Spray Gun is a lightweight professional gun designed to handle both water-based and solvent-based coating materials.

High volume, low pressure (HVLP) models are designed to reduce overspray and provide maximum transfer efficiency by limiting air cap pressure to 0.7 bar (10 psi) (complies with rules issued by SCAQMD and other air quality authorities).

HVLP models will produce approximately 0.7 bar (10 psi) air cap pressure at 1.6 bar (24 psi) gun inlet pressure with the trigger pulled. HVLP air cap HV20 is designed for optimum basecoat applications. An air cap test kit is available (see **Accessories**) which can be utilized to set the exact air cap pressure.

IMPORTANT: These guns are not designed for use with highly corrosive and/or abrasive materials and if used with such materials it must be expected that the need for cleaning and/or replacement of parts will be increased. If there is any doubt regarding the suitability of a specific material, contact your TEKNA Distributor.

NOTE: This gun is **not** to be used with halogenated hydrocarbon solvents or cleaning agents such as **1,1,1-Trichloroethane or methylene chloride. These solvents can react with the aluminium components used in this gun and cup. The reaction can become violent and lead to an equipment explosion.**

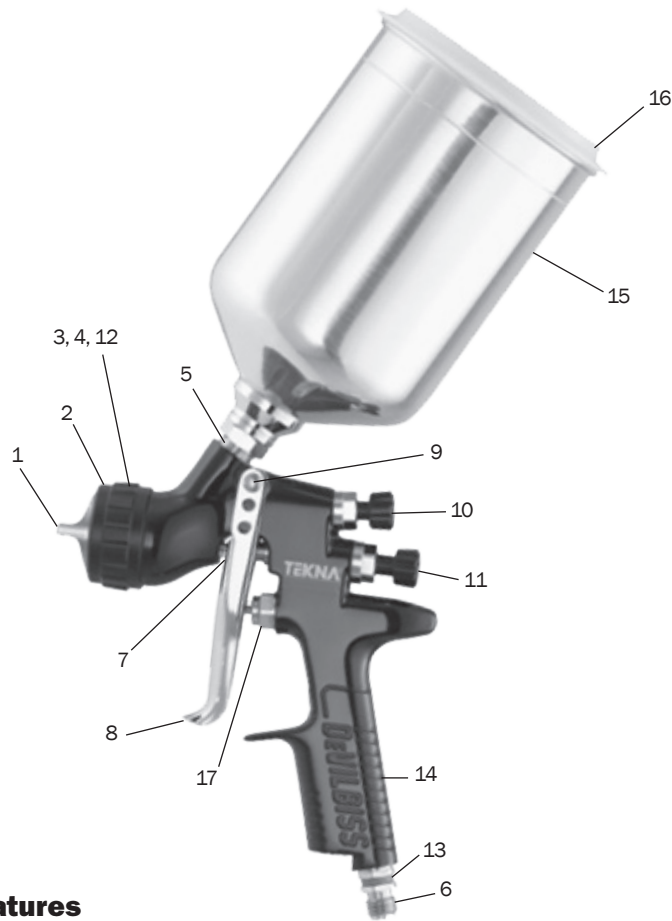

Construction Features

1	Air Cap (nickel plated brass for long durability)
2	Air Cap Retaining Ring (allows easy rotation of air cap)
3	Fluid Nozzle (not visible, ideal for automotive topcoat systems)
4	Fluid Needle (not visible)
5	Fluid Inlet (3/8 BSP thread - accepts TEKNA & DeVilbiss cups)
6	Air Inlet (universal thread, accepts G 1/4 & 1/4 NPS)
7	Self Adjusting Needle Packing (packing not visible, for long packing life)
8	Trigger (ergonomic for comfort)
9	Trigger Stud & Screw (easy replacement design)
10	Fan Air Adjustment (stepless regulation for flat to round spray)
11	Fluid Adjustment (stepless regulation of fluid volume)
12	Removable Air Separator (not visible, for long gun service life)
13	Interchangeable Colour ID System (4 coloured rings supplied)
14	Forged gun body (ergonomic, good looking & durable, easy to clean)
15	900cc Aluminium Cup (easy clean) (shown) or 20 oz. Acetal Cup (waterbourne) (not shown)
16	Push On Lid w/Drip Free Vent (disposable/easy clean design) (aluminum cup) or screw-on lid w/vent (acetal Cup)
17	Air Valve (design offers low pull force & low pressure drop)
18	Gun acceptable for waterborne and solvent borne applications

Materials of Construction

Gun Body	Anodized aluminium
Air Cap	Nickel plated brass
Fluid Nozzle, Fluid Needle, Fluid Inlet, Trigger Stud	Stainless steel
Air Separator, Air Cap Retaining Ring, Knobs	Anodized aluminium
Springs, Clips, Screws	Stainless steel
Seals, Gaskets	Solvent resistant
Trigger	Chrome plated steel
Handle Plug, Air Inlet, Body Bushing, Spreader Valve Body, Air Valve Nut	Chrome plated brass
Air Valve Assembly	Stainless steel, acetal

Specifications & Technical Data

Air Supply Connection	Universal 1/4" BSP and 1/4" NPS
Maximum Static Air Inlet Pressure	P1 = 12 bar (175 psi)
Nominal Gun Air Inlet Pressure for HVLP Model (with gun triggered)	1.6 bar (24 psi)
Air Consumption	See Chart 1 on page 11
Fluid Supply Connection	3/8" BSP
Service Temperature	0 to 40°C (32 to 100°F)
Gun Weight (gun only)	478g (16.9 oz.)

**CA PROP
65**
PROP 65 WARNING

WARNING: This product contains chemicals known to the State of California to cause cancer and birth defects or other reproductive harm.



Safety Precautions

This bulletin contains information that is important for you to know and understand. This information relates to USER SAFETY and PREVENTING EQUIPMENT PROBLEMS. To help you recognize this information, we use the following symbols. Please pay particular attention to these sections.

WARNING**CAUTION****NOTE**

Important safety information – A hazard that may cause serious injury or loss of life.	Important information that tells how to prevent damage to equipment, or how to avoid a situation that may cause minor injury.	Information that you should pay special attention to.
--	---	---

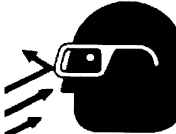
The following hazards may occur during the normal use of this equipment. Please read the following chart before using this equipment.

HAZARD	CAUSE	SAFEGUARDS
Fire 	Solvent and coatings can be highly flammable or combustible especially when sprayed.	<p>Adequate exhaust must be provided to keep air free of accumulations of flammable vapours.</p> <p>Smoking must never be allowed in the spray area.</p> <p>Fire extinguishing equipment must be present in the spray area.</p>
Solvent Spray 	During use and while cleaning and flushing, solvents can be forcefully expelled from fluid and air passages. Some solvents can cause eye injury.	Wear eye protection.
Inhaling Toxic Substances 	Certain materials may be harmful if inhaled, or if there is contact with the skin.	<p>Follow the requirements of the Safety Data Sheet supplied by your coating material manufacturer.</p> <p>Adequate exhaust must be provided to keep the air free of accumulations of toxic materials.</p> <p>Use a mask or respirator whenever there is a chance of inhaling sprayed materials. The mask must be compatible with the material being sprayed and its concentration. Equipment must be as prescribed by an industrial hygienist or safety expert, and be NIOSH approved.</p>
Explosion Hazard – Incompatible Materials 	Halogenated hydrocarbon solvents – for example; methylene chloride and 1,1,1-Trichloroethane are not chemically compatible with the aluminium that might be used in many system components. The chemical reaction caused by these solvents reacting with aluminium can become violent and lead to an equipment explosion.	<p>Guns with stainless steel internal passageways may be used with these solvents. However, aluminium is widely used in other spray application equipment – such as material pumps, regulators, valves, and cups. Check all equipment items before use and make sure they can also be used safely with these solvents.</p> <p>Read the label or data sheet for the material you intend to spray. If in doubt as to whether or not a coating or cleaning material is compatible, contact your material supplier.</p>
General Safety	Improper operation or maintenance of equipment.	Operators should be given adequate training in the safe use and maintenance of the equipment (in accordance with the requirements of NFPA-33, Chapter 15). Users must comply with all local and national codes of practice and insurance company requirements governing ventilation, fire precautions, operation, maintenance, and housekeeping. These are OSHA Sections 1910.94 and 1910.107 and NFPA-33.
Cumulative Trauma disorders (“CTD’s”) CTD’s, or musculoskeletal disorders, involve damage to the hands, wrists, elbow, shoulders, neck and back. Carpal tunnel syndrome and tendonitis (such as tennis elbow or rotator cuff syndrome) are examples of CTD’s.	<p>Use of hand tools may cause cumulative trauma disorders (“CTD’s”).</p> <p>CTD’s, when using hand tools, tend to affect the upper extremities. Factors which may increase the risk of developing a CTD include:</p> <ol style="list-style-type: none"> 1. High frequency of the activity. 2. Excessive force, such as gripping, pinching, or pressing with the hands and fingers. 3. Extreme or awkward finger, wrist, or arm positions. 4. Excessive duration of the activity. 5. Tool vibration. 6. Repeated pressure on a body part. 7. Working in cold temperatures. <p>CTD’s can also be caused by such activities as sewing, golf, tennis, and bowling, to name a few.</p>	<p>Pain, tingling, or numbness in the shoulder, forearm, wrist, hands, or fingers, especially during the night, may be early symptoms of a CTD. Do not ignore them. Should you experience any such symptoms, see a physician immediately.</p> <p>Other early symptoms may include vague discomfort in the hand, loss of manual dexterity, and nonspecific pain in the arm. Ignoring early symptoms and continued repetitive use of the arm, wrist, and hand can lead to serious disability. Risk is reduced by avoiding or lessening factors 1-7.</p>



INSTALLATION

For maximum transfer efficiency, **do not use more pressure than is necessary to atomise the material being applied.**

1. Connect the gun to a clean, moisture and oil free air supply using a hose size of at least 8 mm (5/16") I.D. hose. Do not use 6 mm I.D. hose (8 m x 6 mm hose at 510 LPM has a pressure loss of 1.8 bar. 8 m x 8 mm hose at 510 LPM has a pressure loss of 0.6 bar. [Do not use 1/4" I.D. hose (25' x 1/4" hose at 18 CFM has a pressure loss of 25 psi. 25' x 5/16" hose at 18 CFM has a pressure loss of 8 psi).] Depending on hose length, larger I.D. hose may be required.

NOTE

When gun is triggered on, adjust inlet air pressure (for recommended pressures see Chart 1 under Parts Replacement) at the gun inlet. (Pressure gauge shown under Accessories is recommended for this). **Do not use more pressure than is necessary to atomise the material being applied.** Excess pressure will create additional overspray and reduce transfer efficiency.

NOTE

If quick connects are required, use only high flow quick connects approved for HVLP use. Other types will not flow enough air for proper gun operation.

NOTE

If an air adjusting valve is used at the gun inlet, use a DeVilbiss air adjusting valve. Some competitive adjusting valves have significant pressure drop that can adversely affect spray performance. DeVilbiss air adjusting valves have minimal pressure drop.

2. Attach the gravity feed cup to the material inlet.

NOTE

Protective coating and rust inhibitors have been used to keep the gun in good condition prior to shipment. Before using the gun, flush it with solvents so that these materials will be removed from fluid passages.

OPERATION

1. Mix coating material to manufacturer's instructions and strain material.
2. Fill the cup with the required amount of material. Fill to no more than 19 mm (3/4") from the top of the cup. **DO NOT OVERFILL.**
3. Attach Cup Lid.
4. Turn fluid adjusting knob (18) clockwise to prevent fluid needle movement.
5. Turn spreader valve adjusting knob (23) counter clockwise to fully open.
6. Trigger gun on and adjust inlet air pressure (for recommended figures see Chart 1 under Parts Replacement) at the gun inlet. (Pressure gauge shown under Accessories is recommended for this).
7. Turn fluid adjusting knob counter clockwise until first thread shows.
8. Test spray. If the finish is too dry, reduce airflow by reducing air inlet pressure.

9. If finish is too wet, reduce fluid flow by turning fluid adjusting knob (18) clockwise. If atomisation is too coarse, increase inlet air pressure. If too fine, reduce inlet pressure.
10. The pattern size can be reduced by turning spreader valve adjusting knob (23) clockwise.
11. Hold gun perpendicular to surface being sprayed. Arcing or tilting may result in uneven coating.
12. The recommended spray distance is 150-200 mm (6"-8").
13. Spray edges first. Overlap each stroke a minimum of 75%. Move gun at a constant speed.
14. Always turn off air supply and relieve pressure when gun is not in use.

PREVENTIVE MAINTENANCE & CLEANING

To clean air cap and fluid nozzle, brush exterior with a stiff bristle brush. If necessary to clean cap holes, use a broom straw or toothpick if possible. If a wire or hard instrument is used, extreme care must be used to prevent scratching or burring of the holes which will cause a distorted spray pattern.

To clean fluid passages, remove excess material from cup, then flush with a suitable solvent. Wipe gun exterior with a solvent dampened cloth. Never completely immerse in solvent as this is detrimental to the lubricants and packings.

NOTE

When replacing the fluid nozzle or fluid needle, replace both at the same time. Using worn parts can cause fluid leakage. See page 11, Chart 2. Also, replace the needle packing at this time. Lightly lubricate the threads of the fluid nozzle before reassembling. Torque to 18-20 nm (13-15 ft-lbs). Do not over tighten the fluid nozzle.

CAUTION

To prevent damage to fluid nozzle (8) or fluid needle (15), be sure to either 1) pull the trigger and hold while tightening or loosening the fluid nozzle, or 2) remove fluid adjusting knob (18) to relieve spring pressure against needle collar.

SPRAY GUN LUBRICATION

Daily, apply a drop of spray gun lubricant at trigger stud (39) and the stem of air valve (32) where it enters air valve assembly. The shank of fluid needle (15) where it enters packing nut (28) should also be oiled. Fluid needle packing (26) should be lubricated periodically. Make sure air separator (9) and air cap retaining ring (1) threads are clean and free of foreign matter. Before assembling air cap retaining ring to air separator, clean the threads thoroughly, then add two drops of spray gun lubricant to threads. Fluid needle spring (16) and air valve spring (33) should be coated with a very light grease, making sure that any excess grease will not clog the air passages.

Points of Lubrication

- A. Trigger Points
- B. Packing
- C. Adjusting Knobs
- D. Air Cap Retaining Ring Threads
- E. Air Valve Cartridge

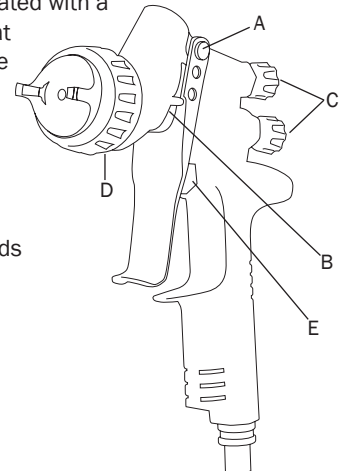

Parts Replacement/ Maintenance

AIR VALVE INSTRUCTIONS

Servicing Air Valve

Reasons to service air valve:

- A) Air valve not functioning properly (may need cleaning).
- B) Routine maintenance.

1. Remove trigger using a Star (T20) driver. (See pictures 7-1 & 7-2)
2. Unscrew air valve using 14 mm wrench. (See picture 7-3)
3. Remove air valve by gripping stem. (See picture 7-4)
4. Remove spring with spring pad. (See picture 7-5)
5. DO NOT REMOVE REAR SEAL FROM GUN BODY. (See picture 7-6)
6. DO NOT REMOVE PLASTIC CAGE FROM AIR VALVE BODY AS THIS MAY DAMAGE THE CAGE. (See picture 7-7)
7. CLEAN
 - a. Remove all paint build up. (See picture 7-8)
 - b. The 4 poppet holes must be clear. (See picture 7-9)
 - c. Stem must be free to float in poppet. (See picture 7-10)
 - d. Stem must slide through cage bore with slight resistance (due to seal).
 - e. Rear seal must look clean and in position in the bore. (See picture 7-6)
 - f. If any of the above cannot be rectified, replace the air valve (See Replacing Air Valve).
8. Replace spring ensuring the end with the plastic bearing pad goes in first. (See picture 7-5)
9. Insert air valve assembly into gun and carefully feed through the rear seal and over the spring. (See picture 7-11)
10. Tighten air valve assembly using fingers first, then wrench tighten with 14 mm wrench. (See pictures 7-12 & 7-3)
11. Replace trigger. (See pictures 7-2 & 7-1)
12. If there is an air leak through the gun, the air valve may need replacing (See Replacing Air Valve).

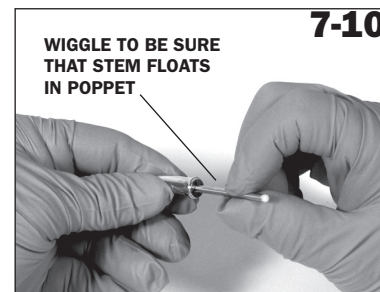
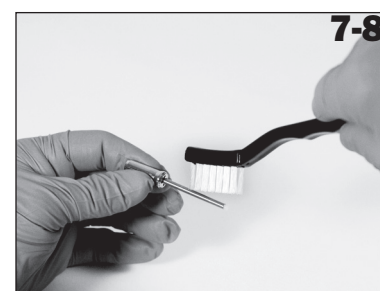
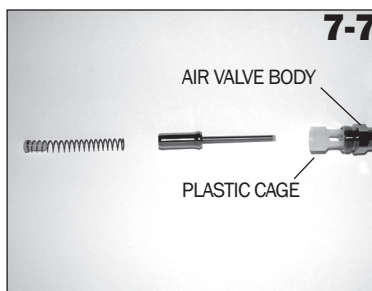
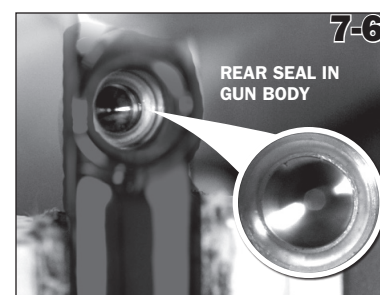
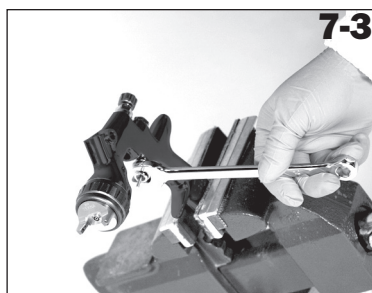

E

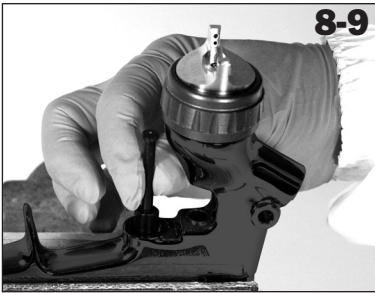
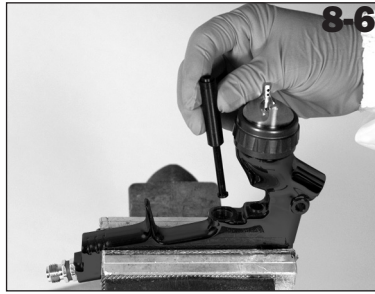
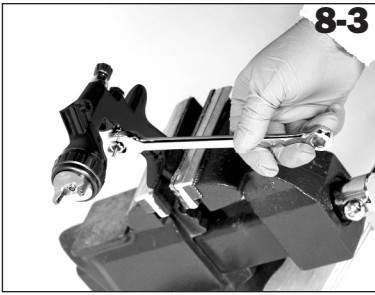
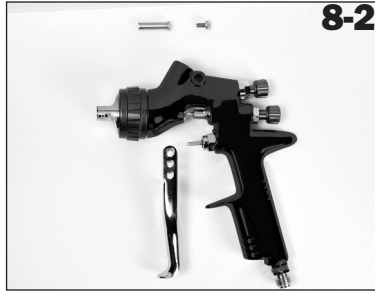
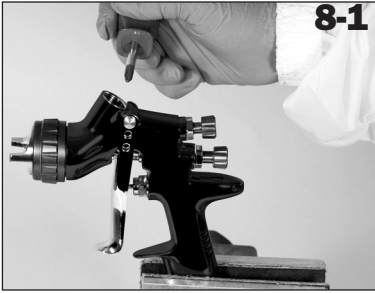

Replacing Air Valve

Reasons to replace air valve:

- A) Air leak through the gun.
 - B) Air valve not operating properly.
1. Remove trigger using a Star (T20) driver. (See pictures 8-1 & 8-2)
 2. Unscrew air valve using 14 mm wrench. (See picture 8-3)
 3. Remove air valve by gripping the stem. (See picture 8-4)
 4. Remove spring with spring pad. (See picture 8-5)
 5. Hook out rear seal using service tool. (See pictures 8-6 & 8-7)
 6. Clean air valve bores in gun body with a soft brush.
 7. Place new rear seal onto service tool; grooves must fit in service tool form. (See picture 8-8)
 8. Push rear seal firmly into hole up to shoulder, using service tool. (See picture 8-9)
 9. Insert new spring, ensuring the end with the plastic bearing pad goes in first. (See picture 8-5)
 10. Insert air valve assembly into gun and carefully feed through the rear seal and over the spring. (See picture 8-10)
 11. Tighten air valve assembly using fingers first, then wrench tighten with 14 mm wrench. (See pictures 8-11 & 8-3)
 12. Replace trigger. (See pictures 8-2 & 8-1)

Parts Replacement/ Maintenance

NEEDLE PACKING REPLACEMENT INSTRUCTIONS

1. Remove trigger using a Star (T20) driver.
(See pictures 9-1 & 9-2)
2. Remove fluid adjusting knob and needle spring with spring pad from gun.
(See pictures 9-3 & 9-4)
3. Remove fluid needle from gun body.
(See picture 9-5)
4. Loosen and remove packing nut using a straight blade screwdriver. (See picture 9-6)
5. Discard old packing and packing spring if replacing. Clean packing if reusing. Also clean packing spring and nut. (See picture 9-7)
6. Partially insert clean fluid needle into gun and place packing nut, spring, and new packing onto needle. Be sure tapered end of packing goes into gun first. (See pictures 9-7 & 9-8)
7. Insert fluid needle all the way into gun body seating in fluid nozzle.
8. Tighten needle packing nut by hand, then remove fluid needle.
9. Tighten needle packing nut fully, using a straight blade screwdriver. Don't over tighten.
(See picture 9-6)
10. Reinstall fluid needle, needle spring, spring pad, and fluid adjusting knob. (See pictures 9-5, 9-4 & 9-3) A drop or two of lubricant on parts assures smooth operation.
11. Reinstall trigger. (See pictures 9-2 & 9-1)
A drop of lubricant assures smooth operation.
12. Trigger gun fully and screw in fluid adjusting knob until it stops. Back it off 1/2 turn and gun will have full needle travel.
13. Trigger gun several times to verify proper operation.

FLUID INSERT REPLACEMENT/ MAINTENANCE

The fluid insert and seal are NOT replaceable. Don't remove these parts. (See picture 9-9)
No maintenance is required for these parts other than cleaning the internal bore.

SPREADER VALVE ASSEMBLY REPLACEMENT/MAINTENANCE

The spreader valve assembly can be replaced if damaged (See picture 9-10). Remove using a 14 mm wrench. The internal seal can be replaced and is included in the TEKNA Gun Rebuild Kit.

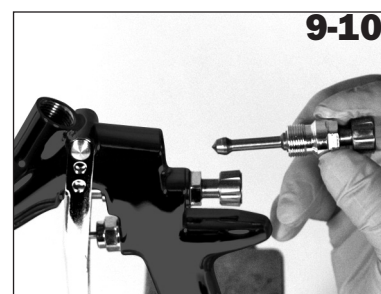
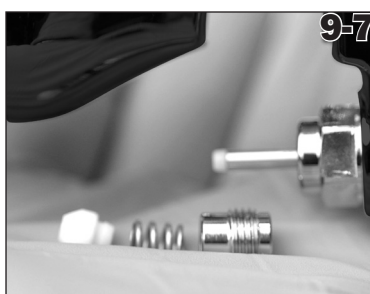
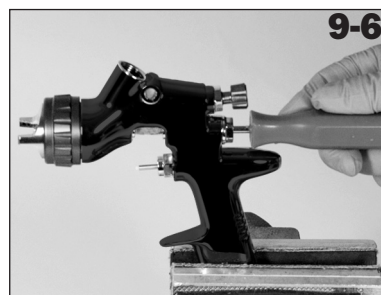
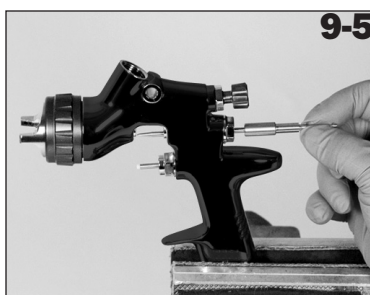
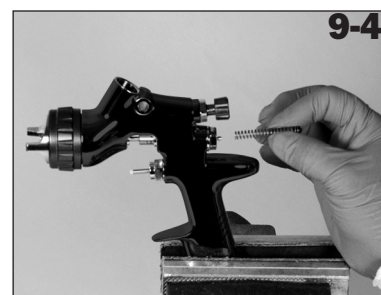

E

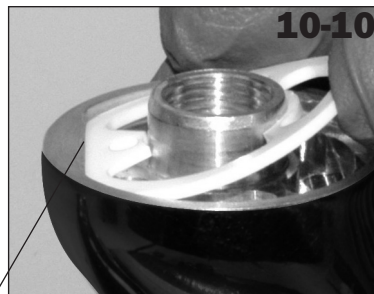
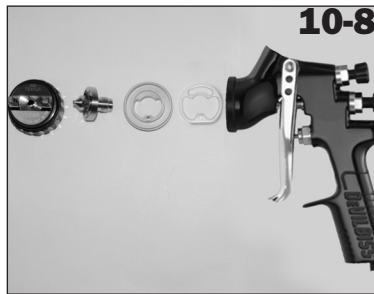
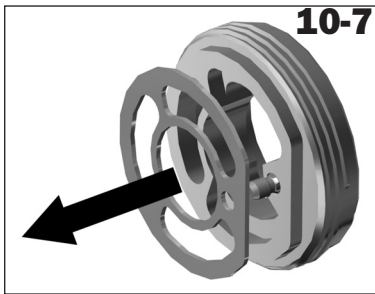
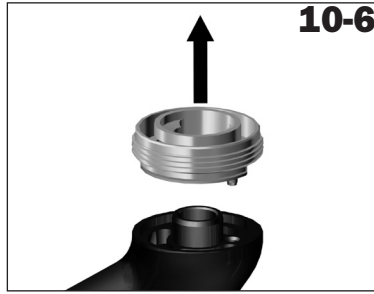
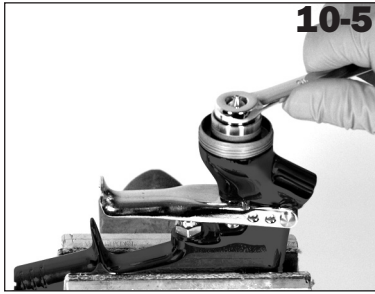
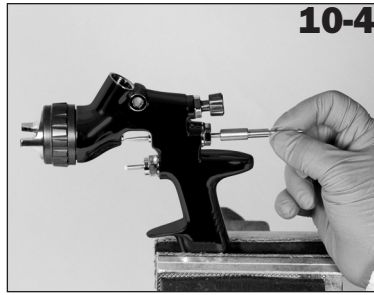
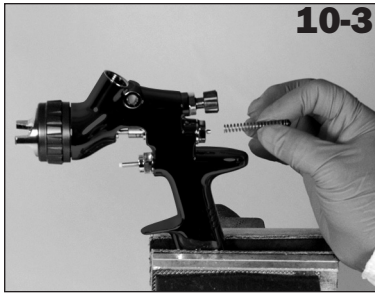
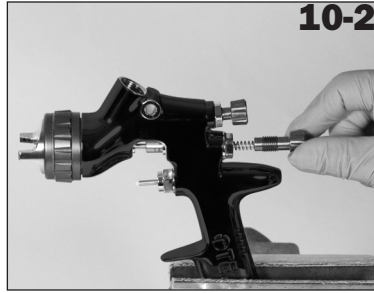

Flats on seal and gun must align.

Parts Replacement/ Maintenance

AIR SEPARATOR SEAL REPLACEMENT

1. Remove air cap and retaining ring.
(See picture 10-1)
2. Remove fluid adjusting knob, spring, and spring pad. (See pictures 10-2 & 10-3)
3. Remove fluid needle from gun body.
(See picture 10-4)
4. Remove fluid nozzle (using 10 mm wrench), air separator, and seal.
(See pictures 10-5 & 10-6)
5. Remove seal from air separator.
(See picture 10-7)
6. Clean front of gun if required, using a soft brush, as well as the air separator, fluid nozzle, air cap, and retaining ring.
(See pictures 10-8 & 10-9)
7. Place a new air separator seal onto the front of the gun. The flat on the seal must align with the gun's flat. (See picture 10-10)
8. Reinstall the air separator, making sure the pin is engaged into the hole in the gun body. Reinstall the fluid nozzle and torque the fluid nozzle to 18–20 nm (13–15 ft-lbs). Don't over torque the fluid nozzle. A drop or two of lubricant on the fluid nozzle threads and air separator threads insures smooth assembly. Reinstall the air cap and retaining ring.
9. Insert fluid needle all the way into the gun body, seating in fluid nozzle.
(See picture 10-4)
10. Reassemble needle spring, spring pad, and fluid adjusting knob. A drop or two of lubricant assures smooth operation.
(See pictures 10-2 & 10-3)
11. Trigger gun fully and screw in fluid adjusting knob until it stops. Back it off 1/2 turn and gun will have full needle travel.
12. Trigger gun several times to verify proper operation.



Parts Replacement/Maintenance

Chart 1 – Air Cap

ORDER NO. FOR AIR CAP	NUMBER ON CAP	RECOMMENDED INLET PRESSURE BAR/PSI	AIR FLOW LPM/SCFM
703899 (HVLP)	HV20	1.0 – 1.3 bar 14 – 18 psi	317 – 368 LPM 11.2 – 13.0 SCFM

NOTE 1: Guns with HVLP caps must not exceed 0.7 bar (10 psi) air cap pressure with gun fully triggered. (Approximately 24 psi gun inlet pressure.) (See accessories for air cap test kit which is available to set the exact cap pressure.)

NOTE 2: When removing air cap from retaining ring, don't remove slip ring (2) or retaining ring seal (5) from retaining ring. Damage to the parts may occur. Slip ring and retaining ring seal are not available as replacements. Simply wipe parts clean and reassemble with new or clean air cap.

Chart 2 – Fluid Nozzles & Fluid Needles

NO. ON FLUID NOZZLE	TIP SIZE I.D. (MM)	NO. ON FLUID NEEDLE (TO MATCH FLUID NOZZLE)	ORDER NO. FOR NOZZLE & NEEDLE SET
SN-37-11	1.1	SN-38-11	702711
SN-37-12	1.2	SN-38-12	702712
SN-37-13	1.3	SN-38-13	702713
SN-37-14	1.4	SN-38-14	702714
SN-37-15	1.5	SN-38-15	702715

NOTE: When replacing the fluid nozzle or fluid needle, replace both at the same time. Lightly lubricate the threads of the fluid nozzle before reassembling. Torque to 18–20 Nm (13–15 ft-lbs). Don't over tighten the fluid nozzle. Use 10 mm wrench supplied with gun.

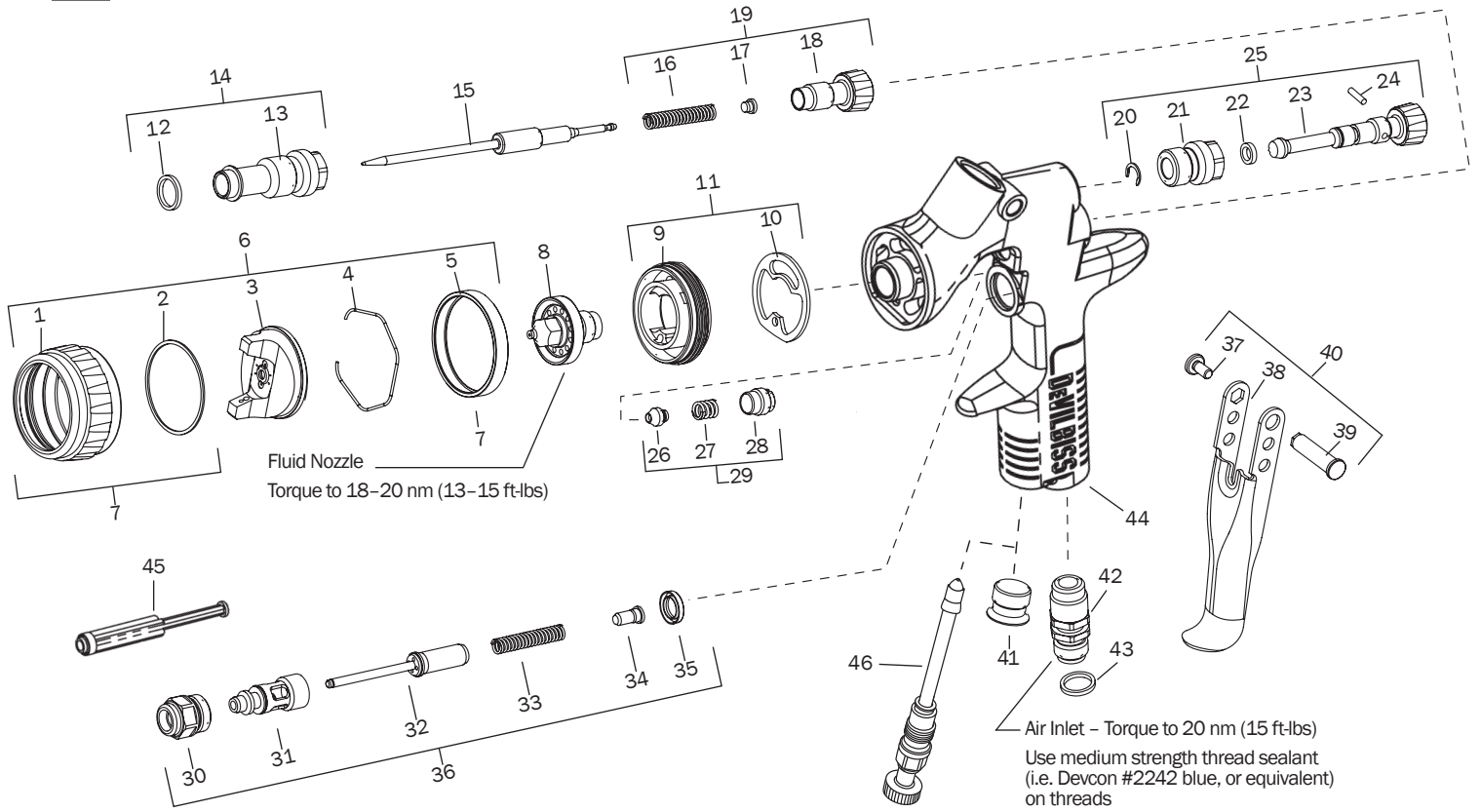





REF. NO.	DESCRIPTION	PART NO.	QTY
1	Air Cap Retaining Ring		1
2	Slip Ring		1
3	Air Cap		1
4	Air Cap Retaining Clip	191972	1
5	Retaining Ring Seal		1
6	Air Cap & Ring	See Chart 1, p.11	1
7	Air Cap Retaining Ring & Seals	703896	1
8	Fluid Nozzle	See Chart 2, p.11	1
9	Air Separator		1
*10	Air Separator Seal (kit of 2)	702726	1
11	Air Separator & Seal Kit	703900	1
*12	Body Bushing Gasket		1
13	Body Bushing		1
14	Body Bushing & Gasket	702728	1
15	Fluid Needle	See Chart 2, p.11	1
*16	Needle Spring		1
*17	Needle Spring Pad		1
18	Fluid Adjusting Knob		1
19	Fluid Adjusting Knob, Spring, & Pad Kit	703897	1
*20	Retaining Clip		1
21	Spreader Valve Body		1
*22	O-ring		1
23	Spreader Valve Adjusting Knob		1
*24	Spreader Valve Pin		1
25	Spreader Valve Assembly	703898	1

REF. NO.	DESCRIPTION	PART NO.	QTY
*26	Needle Packing		1
*27	Packing Spring		1
*28	Packing Nut		1
29	Packing, Spring & Packing Nut Kit	702731	1
30	Air Valve Body		1
31	Air Valve Cage		1
32	Air Valve Poppet		1
33	Air Valve Spring		1
34	Air Valve Spring Pad		1
35	Air Valve Seal		1
36	Air Valve Assembly	702732	1
*37	Trigger Stud Screw (T20 Star)		1
38	Trigger		1
*39	Trigger Stud		1
40	Trigger, Stud & Screw Kit	702733	1
41	Plug		1
42	Air Inlet	702734	1
43	Colour ID Ring Kit (4 Colours)	702735	1
44	Gun Body		1
45	Air Valve Service Tool (only included with Air Valve Assembly 36)		
46	Air Adjusting Valve (optional)	702737	1
OTHER SALABLE PARTS / ACCESSORIES			
	Wrench (10 & 14mm)	702740	
	Seal and Pin Kit (Kit of 5) (Items 20, 22 and 24.)	192229	

* The TEKNA Spray Gun Repair Kit (702736) contains all the parts indicated with an asterisk.

Troubleshooting Possible Problems in Operation

CONDITION	CAUSE	CORRECTION
Heavy top or bottom pattern 	Horn holes plugged. Obstruction on top or bottom of fluid nozzle. Cap and/or nozzle seat dirty.	Clean. Ream with non-metallic point. Clean. Clean
Heavy right or left side pattern 	Left or right side horn holes plugged. Dirt on left or right side of fluid nozzle.	Clean. Ream with non-metallic point. Clean.
Remedies for the top-heavy, bottom-heavy, right-heavy, and left-heavy patterns: <ol style="list-style-type: none"> Determine if the obstruction is on the air cap or the fluid nozzle. Do this by making a test spray pattern. Then, rotate the cap one-half turn and spray another pattern. If the defect is inverted, obstruction is on the air cap. Clean the air cap as previously instructed. Also check for dried paint just inside the cap center hole opening; remove by washing with solvent. If the defect is not inverted, it is on the fluid nozzle. Clean nozzle. Check for a fine burr on the edge of the fluid nozzle. Remove with #600 wet or dry sandpaper. 		
Heavy centre pattern 	Spreader adjustment valve set too low. Atomising pressure too low. Material too thick.	Turn out counter clockwise to achieve proper pattern. Increase pressure. Thin to proper consistency.
Split spray pattern 	Atomisation air pressure too high. Fluid adjusting knob turned in too far. Spreader adjusting valve set too high.	Reduce at regulator or gun handle. Turn out counter clockwise to achieve proper pattern. Turn in clockwise to achieve proper pattern.
Jerky or fluttering spray 	*Loose or damaged fluid nozzle/seat. Loose or broken cup fluid nipple. Material level too low. Container tipped too far. Obstruction in fluid passage. Loose fluid needle packing nut. Damaged fluid needle packing.	Tighten or replace. Tighten or replace cup. Refill. Hold more upright. Back flush with solvent. Tighten. Replace.
Unable to get round spray	Spreader valve not seating properly. Air cap retaining ring loose.	Clean or replace. Tighten.
Will not spray	No air pressure at gun. Fluid adjusting knob not open enough. Fluid too heavy for gravity feed.	Check air supply and air lines, blow out gun air passages. Turn out counter clockwise. Thin material and/or change to larger fluid nozzle size.
Paint bubbles in cup	Fluid nozzle not tight.	Tighten to 18–20 nm (13-15 ft-lbs).
Fluid leaking or dripping from cup lid	Cup lid loose. Dirty cup or lid. Cracked cup or lid.	Push in or replace. Clean. Replace cup and lid.
Starved spray pattern	Inadequate material flow. Low atomisation air pressure.	Back fluid adjusting knob out or change to larger fluid nozzle size. Increase air pressure and rebalance gun.
Excessive overspray	Too much atomisation air pressure. Gun too far from work surface. Improper stroking (arcing, gun motion too fast).	Reduce pressure. Adjust to proper distance. Move at moderate pace, parallel to work surface.
Excessive fog	Too much or too-fast-drying thinner. Too much atomisation air pressure.	Remix properly. Reduce pressure.
Dry spray	Air pressure too high. Gun too far from work surface. Gun motion too fast. Gun out of adjustment.	Reduce air pressure. Adjust to proper distance. Slow down. Adjust.
Fluid leaking from packing nut	Packing nut loose. Packing worn.	Tighten. Replace.

*Most common problem.



Troubleshooting Possible Problems in Operation (cont'd)

CONDITION	CAUSE	CORRECTION
Fluid leaking or dripping from front of gun	Fluid nozzle or fluid needle worn or damaged. Foreign matter in fluid nozzle. Fluid needle spring broken. Wrong size fluid needle or fluid nozzle.	Replace fluid nozzle and fluid needle. Clean. Replace. Replace fluid nozzle and fluid needle.
Fluid dripping or leaking from bottom of cup	Cup loose on gun. Cup threads dirty.	Tighten. Clean.
Runs and sags	Too much material flow. Material too thin. Gun tilted on an angle, or gun motion too slow.	Turn fluid adjusting knob clockwise or switch to smaller fluid nozzle and fluid needle size. Mix properly or apply light coats. Hold gun at right angle to work and adapt to proper gun technique.
Thin, sandy coarse finish drying before it flows out	Gun too far from surface. Too much air pressure. Improper thinner being used.	Check distance. Normally approx. 150-200 mm (6-8"). Reduce air pressure and check spray pattern. Follow paint manufacturer's mixing instructions.
Thick, dimpled finish "orange peel"	Gun too close to surface. Air pressure too low. Improper thinner being used. Material not properly mixed. Surface rough, oily, dirty.	Check distance. Normally approx. 150-200 mm (6-8"). Too much material coarsely atomised. Increase air pressure or reduce fluid flow. Follow paint manufacturer's mixing instructions. Follow paint manufacturer's mixing instructions. Properly clean and prepare.

Accessories

**702576
TEKNA 900cc
Aluminum Cup**

Easy to use and clean design.

**HAV-555
DeVilbiss
Air Adjusting Valve
with Gauge**

Use to precisely set air pressure to gun.

**HAV-512
Adjusting Valve**

Use to control air usage at gun.

**192212 Professional
Spray Gun
Cleaning Kit**

Contains six precision tools designed to effectively clean all DeVilbiss, Binks, Finishline and other brand spray guns.

**JGA-156-K10
Spring Clips**

Joins any single piece DeVilbiss air cap with latest version retaining ring. Helps prevent part loss and provides easier assembly.

**192218 Scrubs®
Hand Cleaner Towels**

Scrubs® are a pre-moistened hand cleaner towel for painters, body men and mechanics that go where you go and no water is needed.

**703901
HV20 Air Cap Test Kit**

The purpose of this test kit is to measure air cap atomizing air pressure at the center air port of the air cap. Used to confirm code compliance and as a daily quality control measure.

**Champion™
Disposable Respirator
803611 (Medium)
803612 (Large)**

NIOSH-Certified for respiratory protection.

**803616
Multi Spray Gun
Holder**

Gun holder for up to three gravity feed spray guns.

**192219
Gun Holder**

Gun holder made to hold guns with gravity cups.

**Spray Gun Lube
803888 (2 oz. bottle)**

Compatible with all paint materials; contains no silicone or petroleum distillates to contaminate paint. SDS Sheet available upon request.

**Automotive Refinish Quick Connects
For HVLP Guns (Air)
High Flow Type.**

HC-4419 Stem 1/4" NPT(F)
HC-4719 Coupler 1/4" NPT(M) /NPS(M)
HC-1166 Stem 1/4" NPT(M)
HC-4720 Coupler 1/4" NPT(F)

**HAF-507 Whirlwind™
In-Line Air Filter**

Removes water, oil, and debris from the air line.

702740 TEKNA Wrench

14 mm 10 mm
For maintenance use.



This product is manufactured in the UK by:
Finishing Brands UK, Ltd.
Ringwood Road,
Bournemouth,
BH11 9LH, UK

Distributed exclusively in North America by:
DeVilbiss Automotive Refinishing
Swanton, OH 43558

DEVILBISS
AUTOMOTIVE REFINISHING



WARRANTY POLICY

DeVilbiss products are covered by Finishing Brands two year materials and workmanship limited warranty. The use of any parts or accessories, from a source other than Finishing Brands, will void all warranties. For specific warranty information please contact the closest Finishing Brands location listed below.

Finishing Brands reserves the right to modify equipment specifications without prior notice. DeVilbiss®, Ransburg®, BGK®, and Binks® are registered trademarks of Carlisle Fluid Technologies, Inc., dba Finishing Brands. ©2015 Carlisle Fluid Technologies, Inc., dba Finishing Brands. All rights reserved.



DeVilbiss Automotive Refinishing is part of Finishing Brands, a global leader in innovative spray finishing technologies. For technical assistance or to locate an authorized distributor, contact one of our sales and customer support locations below.

USA/Canada

www.autorefinishdevilbiss.com
askus@carlisleft.com
Toll Free Tel: 1-800-445-3988
Toll Free Fax: 1-800-445-6643

Mexico

www.autorefinishdevilbiss.com.mx
Toll Free Tel: 1-888-835-6232 USA

